

# Measuring insert for thermocouple Model TC10-A

WIKA data sheet TE 65.01



for further approvals  
see page 6

## Applications

- For all industrial and laboratory applications
- Replacement measuring insert for servicing

## Special features

- Application ranges from 0 ... 1,200 °C
- Made of mineral-insulated sheathed cable
- For all standard thermowell designs
- Spring-loaded design
- Explosion-protected versions



### Measuring inserts for thermocouples

Fig. left: model TC10-A, standard version

Fig. right: model TC10-A, with recessed soldering lugs (option)

## Description

The measuring inserts per DIN 43735 for resistance thermometers described here are designed for installation in a protection assembly. Operation without a thermowell is only advisable in special cases. The measuring insert is manufactured from bendable, mineral-insulated sheathed cable. The sensor is located in the tip of the measuring insert. The measuring inserts are delivered with loading springs to ensure a good contact to the thermowell floor.

Apart from the DIN versions, customer specific versions are available, for example:

- other measuring insert lengths (also intermediate lengths)
- with mounted sleeve to suit inner diameter of the thermowell
- without terminal block
- with transmitter

Type and number of sensors, accuracy and method of connection can each be selected to suit the respective application.

The range of applications is completed by designs without terminal block for direct transmitter installation. Optionally, analogue or digital transmitters from the WIKA range can be installed.







## Explosion protection

The classification/suitability of the instrument (permissible power  $P_{max}$  as well as the permissible ambient temperature) for the respective category can be seen on the EC-type examination certificate, the IECEx certificate or in the operating instructions.

### Attention:

Depending on the version, the measuring inserts can be used in "intrinsically safe Ex i" or "non-incendive Ex n" ignition protection types when built into model TC10-B, TC10-C, TC10-F or TC81 resistance thermometers. With the correspondingly suitable protective fitting, operation in dust Ex hazardous areas is possible.

**The use of a model TC10-A measuring insert is not permitted in hazardous areas without a suitable protective housing!**

Explosion protection	Ignition protection type	Zone
ATEX 	Ex i	Zone 1, gas [Ex ia ... Gb]
	Ex n	Zone 2, gas
IECEX (in conjunction with ATEX) 	Ex i	Zone 1, gas [Ex ia ... Gb]
GOST-R-Ex 	Ex i	Zone 1, gas Ex ib IIC T3/T4/T5/T6
	Ex n	Zone 2, gas Ex nA/Ex nL IIC T6 ... T1
NEPSI 	Ex i	Zone 1, gas [Ex ia ... Gb]
	Ex n	Zone 2, gas [Ex nA II T1 ... T6]
KOSHA 	Ex i	Zone 1, gas [Ex ib IIC T4 ... T6]
INMETRO 	Ex i	Zone 1, gas [Ex ia ... Gb]
PESO	Ex i	Zone 1, gas [Ex ia ... Gb]
NAMUR NE24 	Ex i	-

# Sensor

## Thermocouple per DIN EN 60584-1

Types K, J, E, N, T (single or dual element)

### Measuring point

- Welded insulated (ungrounded, standard)
- Welded to the bottom (grounded)

### Sensor types

Types	Recommended max. operating temperature
K (NiCr-Ni)	1,200 °C
J (Fe-CuNi)	800 °C
N (NiCrSi-NiSi)	1,200 °C
E (NiCr-CuNi)	800 °C
T (Cu-CuNi)	350 °C

Thermocouple type	Class	
	DIN EN 60584 part 2	ISA MC96.1
K	1 and 2	Standard, special
J	1 and 2	Standard, special
N	1 and 2	-
E	1 and 2	-
T	1 and 2	-

### Tolerance value

For the tolerance value of thermocouples, a cold junction temperature of 0 °C has been taken as the basis.

For detailed specifications for thermocouples, see Technical information IN 00.23 at [www.wika.com](http://www.wika.com).

The application range of these thermometers is limited both by the permissible max. temperature of the thermocouple and by the max. temperature of the thermowell material.

### Electrical connection

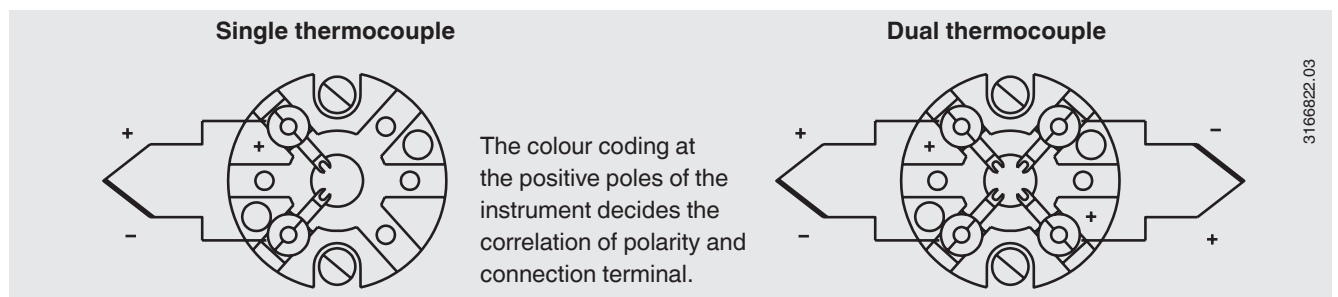

For the electrical connections of built-in temperature transmitters see the corresponding data sheets or operating instructions.

## Transmitter (option)

### Output signal 4 ... 20 mA, HART® protocol, FOUNDATION™ fieldbus and PROFIBUS® PA 1)

Transmitter (selectable versions)	Model T12	Model T32	Model T53
Data sheet	TE 12.03	TE 32.04	TE 53.01
Output			
■ 4 ... 20 mA	x	x	
■ HART® protocol		x	
■ FOUNDATION™ Fieldbus and PROFIBUS® PA			x
Galvanic isolation	yes	yes	yes

1) Protect the temperature transmitter from temperatures over 85 °C.

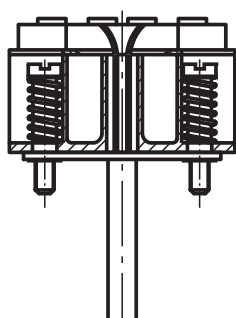

Measuring insert with mounted transmitter  
(here: model T32)

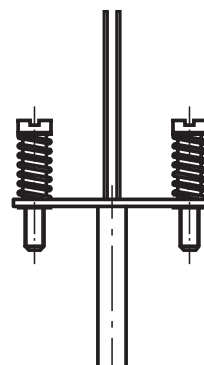

Measuring insert prepared for transmitter mounting

## Functional safety (option) with temperature transmitter model T32



In safety-critical applications, the entire measuring chain must be taken into consideration in terms of the safety parameters. The SIL classification allows the assessment of the risk reduction reached by the safety installations.

Selected TC10-A measuring inserts in combination with a suitable temperature transmitter (e.g. model T32.1S, TÜV certified SIL version for protection systems developed in accordance with IEC 61508) are suitable as sensors for safety functions to SIL-2.

Matched thermowells allow easy dismounting of the measuring insert for calibration. The optimally matched measuring point consists of a thermowell, a thermometer with built-in TC10-A measuring insert and a T32.1S transmitter developed in accordance with IEC 61508. Thus, the measuring point provides maximum reliability and a long service life.

## Dimensions in mm

The replaceable measuring insert is made of a vibration-resistant, sheathed, mineral-insulated cable (MI cable).

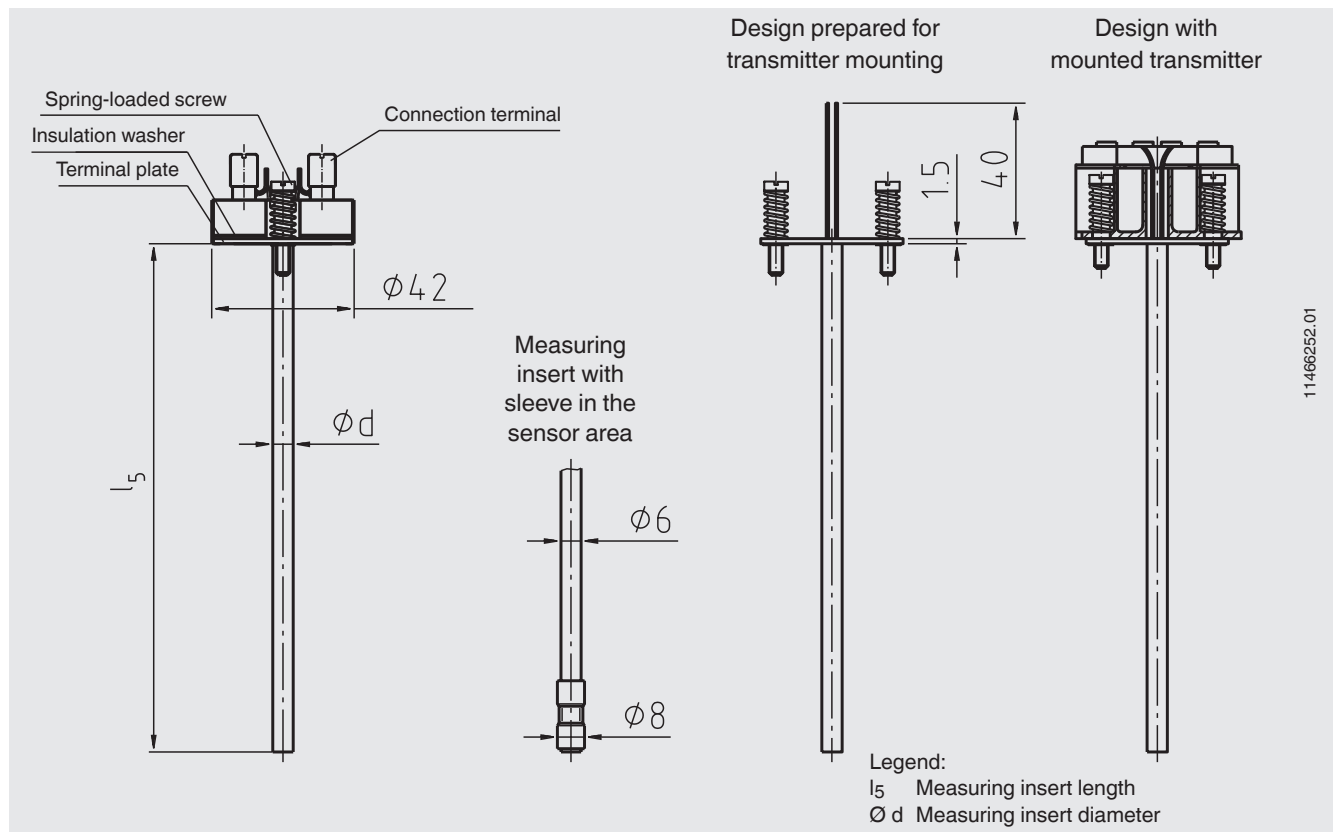

Measuring insert length $l_5$ in mm	Tolerance in mm
75 ... 825	+2 0
> 825	+3 0

Measuring insert diameter $\text{Ø } d$ in mm		Index per DIN 43735	Tolerance in mm
3 <sup>1)</sup>	Standard	30	$3 \pm 0.5$
6	Standard	60	$6 \begin{smallmatrix} 0 \\ -0.1 \end{smallmatrix}$
8 (6 mm with sleeve)	Standard	-	$8 \begin{smallmatrix} 0 \\ -0.1 \end{smallmatrix}$
8	Standard	80	$8 \begin{smallmatrix} 0 \\ -0.1 \end{smallmatrix}$
1/8 inch (3.17 mm) <sup>1)</sup>	Option, on request	-	-
1/4 inch (6.35 mm)			
3/8 inch (9.53 mm)			

1) Not possible with 2 x Pt100, 4-wire

Only correct measuring insert length and correct measuring insert diameter ensure sufficient heat transfer from thermowell to the measuring insert.

The bore diameter of the thermowell should be a max. 1 mm larger than the measuring insert diameter.

Gaps of more than 0.5 mm between thermowell and the measuring insert will have a negative effect on the heat transfer, and they will result in unfavourable response behaviour from the thermometer.

When fitting the measuring insert into a thermowell, it is very important to determine the correct insertion length (= thermowell length for bottom thicknesses of  $\leq 5.5$  mm). In order to ensure that the measuring insert is firmly pressed down onto the bottom of the thermowell, the insert must be spring-loaded (spring travel: max 10 mm).

## Materials

Material	
Sheath material	Ni-alloy 2.4816 (Inconel 600)

Other sheath materials on request.

## CE conformity

### EMC directive <sup>1)</sup>

2004/108/EC, EN 61326 emission (group 1, class B) and interference immunity (industrial application)

### ATEX directive (option)

94/9/EC

## Approvals (option)

- **IECEX**, international certification for the Ex area
- **NEPSI**, ignition protection type "i" - intrinsic safety, ignition protection type "n", China
- **GOST-R**, import certificate, Russia
- **GOST**, metrology/measurement technology, Russia
- **INMETRO**, Institute of Metrology, Brazil
- **KOSHA**, ignition protection type "i" - intrinsic safety, South Korea
- **PESO (CCOE)**, ignition protection type "i" - intrinsic safety, India

## Certificates (option)

Certification type	Measuring accuracy	Material certificate
2.2 test report	x	x
3.1 inspection certificate	x	-
DKD/DAkkS calibration certificate	x	-

The different certifications can be combined with each other.

1) Valid only with built-in transmitters

Approvals and certificates, see website

## Ordering information

Model / Explosion protection / Ignition protection type / Zone / Sensor / Accuracy class / Application range of the thermometer / Measuring insert length  $l_5$  / Measuring insert diameter  $\varnothing d$  / Sheath material / Mechanical requirements / Certificates / Options

© 2003 WIKA Alexander Wiegand SE & Co. KG, all rights reserved.  
The specifications given in this document represent the state of engineering at the time of publishing.  
We reserve the right to make modifications to the specifications and materials.



## Operating conditions

### Mechanical requirements

The replaceable measuring insert is made of a vibration-resistant, sheathed, mineral-insulated cable (MI cable).  
Standard vibration resistance: 50 g (sensor tip)

### Response time (in water)

$t_{50} < 5$  s

$t_{90} < 10$  s

Specifications for measuring insert diameter 6 mm

The thermowell required for operation increases the response time dependent upon the actual parameters for the thermowell and the process.

### Ambient and storage temperature

{-50} -40 ... +80 °C

{ } Items in curved brackets are available optional extras

### Ingress protection

IP 00 per IEC 529/EN 60530

The model TC10-A measuring inserts are designed for mounting into a thermocouple.

These thermocouples feature connection housings/cable glands/protective fittings which ensure a high IP protection.