

Type 100 Series Threaded Capsule Diaphragm Seal



TYPE 100 SHOWN

When isolation of the process from an instrument is required, Ashcroft® offers a comprehensive line of diaphragm seals. Seal types include threaded, flanged, in-line threaded, in-line flanged, in-line socket weld, in-line butt weld, saddle and sanitary seals. Also available is a complete offering of isolation or iso-rings and isolation or iso-spools.

APPLICATIONS

- Elevated process temperatures
- Corrosive service
- Isolation of the process for safety
- Suspended solids in the process
- Sanitary connections
- Minimize process dead leg
- Ease of cleaning between batches

FEATURES

- The top housing and diaphragm capsule are interchangeable with all Ashcroft bottom housings.
- A fill/bleed connection is standard, which permits filling the seal and instrument simultaneously after evacuation and allows the fill to flow into the completed unit.
- A Viton O-ring, compatible with all standard fill fluids, and a Teflon back-up ring provide a seal between the diaphragm capsule and the top housing.
- A thin Teflon PTFE gasket between the diaphragm and bottom housing ensures a leak-tight corrosion resistant seal even at high pressure.
- Top housing and pressure instrument are removable.
- Continuous-duty design will prevent loss of process fluid if pressure instrument is removed or fails.

SPECIFICATIONS

Model Number: Type 100, 101, 102, 103, 104, 105, 106, 107, 108

Process Connection Size: See Table A (Pg. 2)

Instrument Connection Size: ¼, ½ NPT

Diaphragm Material: See Table B (Pg. 2)

Bottom Housing Materials: See Table C (Pg. 2)

Filling Fluid: Glycerin, Halocarbon, Silicone, Stylytherm

OPTIONS

	Code
316 stainless steel top housing	YT
Stainless steel clamp rings and flanged ring – includes 300 stainless steel clamping bolts (1500 psi max)	SE
300 series stainless steel clamping bolts (max pres is 1500 psi)	SB
Pipe plugs for flushing connections – pipe plugs are available in the same materials as bottom housings per Table C (Pg. 2)	PU
5000 psi pressure rating Threaded inlet and metal diaphragm only	HP
Welded instrument to diaphragm seal	DU
Dual flushing connections (½ NPT) (Limited to 2" thru 3" flanged seals)	DB
Ring joint (Flanged seal only)	RJ
Flat face (Flanged seal only)	FF
Clean for gaseous oxygen or strong oxidizing agent applications	6B

Type 100 Series Threaded Capsule Diaphragm Seal

TYPE 100 SERIES THREADED CAPSULE SEAL TYPES

Type 100 – Threaded
 ¼, ½, ¾, 1 NPT



Type 101 – Threaded
 with flushing connection
 ¼, ½, ¾, 1 NPT



Type 102 – Raised Face Flanged
 ½, ¾, 1, 1½, 2, 3"



Type 103 – Raised Face Flanged
 ½, ¾, 1, 1½, 2, 3
 with flushing connection



Type 104 – In-line Threaded
 ¼, ½, ¾, 1 NPT



Type 105 – Saddle
 3, 4" pipe only



Type 106 – In-line Flanged
 ½, ¾, 1, 1½, 2, 3, 4, 6, 8"



Type 107 – In-line Socket Weld
 ½, ¾, 1, 1½, 2"



Type 108 – In-line Butt Weld
 ¼, ½, ¾, 1, 1½, 2"



Table A – Process Connection/Type Number

Process Connection	Process Connection Size/Code—Inches											Type Number
	Size Code	¼	½	¾	1	1½	2	3	4	6	8	
Threaded—female NPT	25	50	75	10	15	20	30	40	60	80		100
Threaded—female NPT (with flushing conn.)	•	•	•	•	•							101
Flanged ⁽¹⁾		•	•	•	•	•	•					102
Flanged (with flushing conn.)		•	•	•	•	•	•					103
In-line—threaded NPT	•	•	•	•								104
Saddle								•	AND LARGER			105
In-line—butt weld	•	•	•	•	•	•						108
In-line—flanged ⁽²⁾		•	•	•	•	•	•	•	•	•	•	106
In-line—socket weld	•	•	•	•	•	•	•	•	•	•	•	107

Pressure Ratings—All 2500 psi except flanged seals are per ASME B 16.5, temperature limit determined by diaphragm, bottom housing and/or filling fluid.

Table B – Diaphragm Material

Material	Code
316L stainless steel	S
304L stainless steel	C
Monel 400	P
Nickel	N
Carpenter 20	D
Tantalum	U
Hastelloy B	G
Hastelloy C 22 ⁽³⁾	J
Hastelloy C 276 ⁽³⁾	H
Halar Coated Monel	R
Gold Plated 304 SS	W

Table C – Housing Materials

Bottom	Code
Steel	B
304L SS	C
316L SS	S
Hastelloy B	G
Hastelloy C 22 ⁽³⁾	J
Hastelloy C 276 ⁽³⁾	H
Carpenter 20	D
Monel "400"	M
Inconel "600"	W
Nickel	N
PVC ⁽⁴⁾⁽⁹⁾	V
Tantalum clad SS ⁽⁵⁾	SU
Halar coated SS ⁽⁶⁾	BH
Teflon flanged steel ⁽⁷⁾	T
Kynar ⁽⁸⁾⁽⁹⁾	KY
Titanium	TI

Table D – Instrument Connection

Size – NPT	Code
¼	O2T
½	O4T

Table E – Filling Fluid

Filling	Service	Connection to Instrument	Temperature Range °F	Code
Glycerin	Pressure	Direct Only	0/400	CG
Silicone	Pressure/Vacuum	Direct or Flexible Line	-40/600	CK
Halocarbon	Pressure/Vacuum in presence of strong oxidizing agent	Direct or Flexible Line	-70/300	CF
Syltherm	Pressure/Vacuum	Direct or Flexible Line	-40/750	HA

Notes:

- (1) 150, 300, 600, 900, 1500 & 2500 class flanges.
- (2) 1" 150 thru 8" 300 class flanges only.
- (3) Use on applications where NACE standard MR-01-75/ISO 1516 w/Sept. 2005 corrigendums.
- (4) Maximum Press./Temp. Threaded: 200 psi/74°F, 125 psi/125°F, 80 psi/150°F. Flanged: 75 psi/100°F.
- (5) Type 102 only.
- (6) Type 102 only – Temp. Limits: -40/300°F.
- (7) Only available in 1", 1½", & 2" 150 class, Types 102. Max. Press./Temp. – 270 psi and 150°F. Consult factory for conditions beyond these limits.
- (8) Maximum Pressure/Temp.: 200 psi and 180°F.
- (9) Type 100: ¼ or ½ NPT only. Larger sizes offered with solvent weld joint. N/A in 101 or 103 design.

Monel is a registered trademark of Huntington Alloys, Inc.
 Hastelloy is a registered trademark of Cabot Corp.
 Halocarbon is a registered trademark of Halocarbon Products
 GYLON 3510 is a registered trademark of Garlock Inc.

HOW TO ORDER:

- From Table A...select TYPE NUMBER based on process connection, process connection size and diaphragm type/construction. (e.g., Threaded/1"capsule-code-10-100)
 - From Table B...select DIAPHRAGM MATERIAL. (e.g., 316L stainless steel-code S)
 - From Table C...select BOTTOM HOUSING MATERIAL. (e.g., 316 stainless steel-code S)
 - From Table D...select INSTRUMENT CONNECTION size. (e.g., ¼ NPT-code O2T)
 - From Table E...select FILLING FLUID, if diaphragm seal will be attached to instrument. (e.g., Glycerin-code CG)
- Typical code: 10-100SS-O2T-CG

Type 100 Series Threaded Capsule Diaphragm Seal

DIMENSIONS

Type 100 – Threaded

¼, ½, ¾, 1 NPT

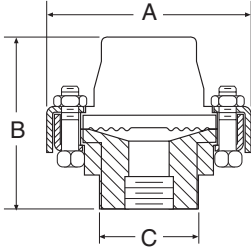

A		B		C	
in	mm	in	mm	in	mm
¾	(95)	2⅞	(73)	1⅞	(46)

Type 101 – Threaded

¼, ½, ¾, 1 NPT (with flushing connection)

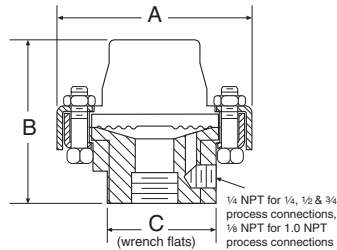

A		B		C	
in	mm	in	mm	in	mm
¾	(95)	2⅞	(73)	1⅞	(46)

Type 102 – Flanged

½", ¾"

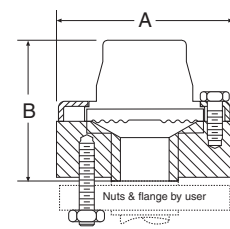

Flange Size	Rating #	A		B	
		in	mm	in	mm
150		3½	(89)	2⅞	(75)
½"	300 or 600	3¾	(95)	3	(76)
900 or 1500		4¾	(121)	3⅞	(81)
150		3⅞	(98)	2⅞	(71)
¾"	300 or 600	4⅞	(117)	3	(76)
900 or 1500		5⅞	(130)	3⅞	(81)

Type 102 – Flanged 1" (raised face only)

one piece bottom housing, with and without flushing connection

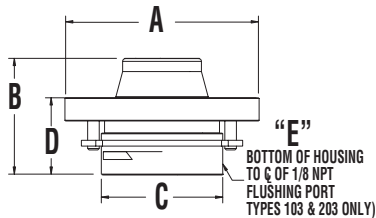

Flange Size	Rating #	A		B		C	
		in	mm	in	mm	in	mm
1	150 300 or 600	4-1/4 5	(100) (127)	2-9/16	(65)	1-23/32	(69)

Flange		103 & 203 only			
Size	Rating #	D	E		
		in	mm		
1	150 300 or 600	1-5/8	(41)	3/8	(9)

Type 102 – Flanged 1" (raised face only)

one piece bottom housing, with and without flushing connection

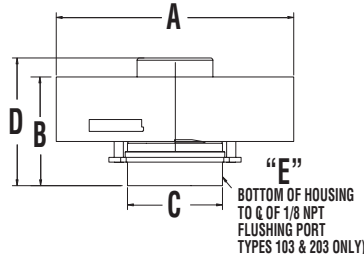

Flange Size	Rating #	A		B		C	
		in	mm	in	mm	in	mm
1	900 or 1500 2500	5-7/8 6-1/4	(149) (159)	2-7/8	(73)	2-1/4	(57)

Flange		103 & 203 only			
Size	Rating #	D	E		
		in	mm		
1	900 or 1500 2500	3-3/8	(86)	3/8	(9)

Type 102 – Flanged (raised face only)

1½", 2", 3" one piece bottom housing - all materials except PVC, Teflon and Kynar

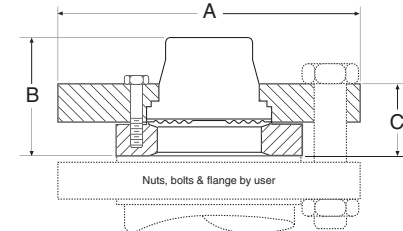

Flange Size	Rating #	A		B		C	
		in	mm	in	mm	in	mm
150		5	(127)			1½	(38)
1½"	300 or 600	6¼	(159)	2⅞	(61)	1½	(38)
900 or 1500		7	(178)			1½	(38)
150		6	(152)			1¾	(35)
2"	300 or 600	6½	(165)	1⅞	(49)	1½	(38)
900 or 1500		8½	(216)			2½	(54)
150		7½	(191)	2	(51)	1¾	(41)
3"	300 or 600	8¼	(206)	2⅞	(52)	1⅞	(47)
900 or 1500		10½	(267)	2⅞	(68)	3¼	(82)

Type 102 – Flanged 1" (raised face only)

two piece bottom housing, 1½", 2", - PVC, Teflon and Kynar

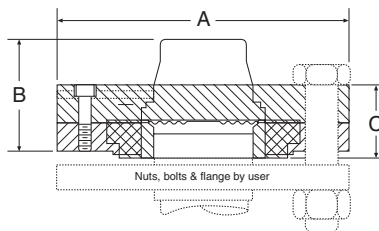

Flange Size	Rating #	A		B		C	
		in	mm	in	mm	in	mm
1½"	150	5	(127)	2⅞	(59)	1⅞	(39)
2"	150	6	(152)	2½	(54)	1⅞	(40)

Type 103 – Flanged

½", ¾" (with flushing connection)

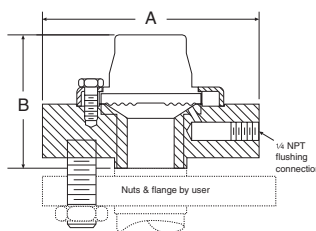

Flange Size	Rating #	A		B	
		in	mm	in	mm
150		3½	(89)	2⅞	(75)
½"	300 or 600	3¾	(95)	3	(76)
900 or 1500		4¾	(121)	3⅞	(81)
150		3⅞	(98)	2⅞	(71)
¾"	300 or 600	4⅞	(117)	3	(76)

Type 100 Series Threaded Capsule Diaphragm Seal

DIMENSIONS

Type 103 – Flanged 1½", 2", 3" (raised face only)
 one piece bottom housing with flushing connection

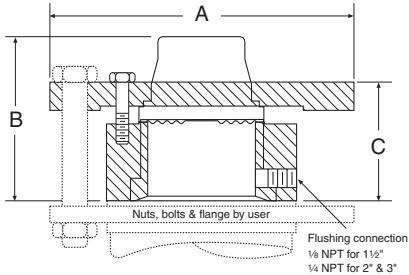

Flange Size	Rating #	A in	A mm	B in	B mm	C in	C mm
150		5	(127)				
1½"	300 or 600	6¼	(159)	3	(76)	2½	(64)
	900 or 1500	7	(178)				
2"	300 or 600	6	(152)	3½	(89)	2¾	(71)
	900 or 1500	6½	(165)	3½	(89)	2¾	(71)
		8½	(215)				
3"	150	7½	(191)	3¾	(94)	2¾	(71)
	300 or 600	8¼	(210)	3¾	(94)	2¾	(71)
	900	9½	(241)				
	1500	10½	(267)				

Type 105 – Saddle
 4" Pipe only

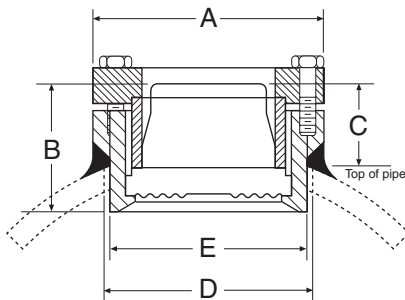

A in	A mm	B in	B mm	C in	C mm	D in	D mm	E in	E mm
3½	(89)	1½	(50)	1¾	(31)	3	(76)	2¾	(71)

Type 104 – In-Line Threaded
 ¼, ½, ¾, 1 NPT

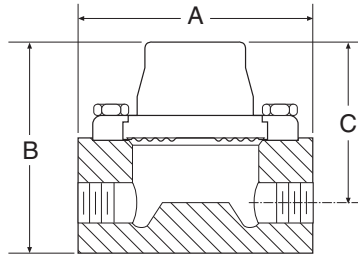

Process Connection	A in	A mm	B in	B mm	C in	C mm
¼ NPT			2½	(67)	2½	(64)
½ NPT	4	(102)	3½	(92)	2¾	(71)
¾ NPT			3¾	(98)	3	(76)
1 NPT			3¾	(98)	3	(76)

Type 106 – In-Line Flanged
 ½", 1", 1½", 2", 3"

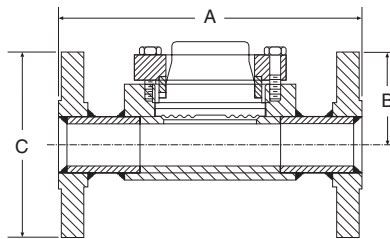

Flange Size	Rating #	A in	A mm	B in	B mm	C in	C mm
150		7	(178)				
½"	300	7	(178)	2¾	(67)	3½	(89)
				3¾	(94)		
1"	150	7	(178)	2¾	(67)	4¼	(108)
	300	8	(203)			4¾	(123)
1½"	150	8	(203)	2½	(67)	5	(127)
	300	9	(229)			6½	(165)
2"	150	9	(229)	2½	(67)	6	(152)
	300	10	(254)			6½	(165)
3"	150	11	(279)	3½	(92)	7½	(229)
	300	12	(305)			8¼	(254)

Type 105 – Saddle
 3" Pipe only

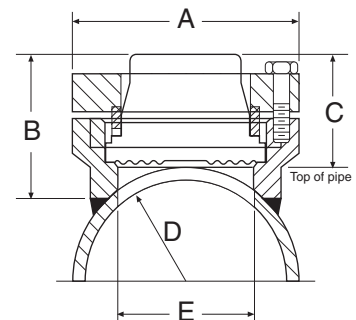

A in	A mm	B in	B mm	C in	C mm	D in	D mm	E in	E mm
3½	(89)	2¼	(57)	1¾	(48)	1¾	(44)	2½	(64)

Type 106 – In-Line Flanged
 4", 6", 8"

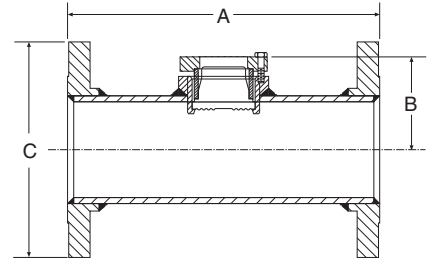

Flange Size	Rating #	A in	A mm	B in	B mm	C in	C mm
150		13	(330)				
4"	300	14	(356)	3¾	(86)	9	(229)
				10	(254)		
6"	150	16	(406)	4¾	(113)	11	(279)
	300	17	(432)			12½	(318)
8"	150	16	(406)	5¾	(138)	13½	(343)

Type 107 – In-Line Welded
 ¼", ½", ¾", 1", 1½", 2"

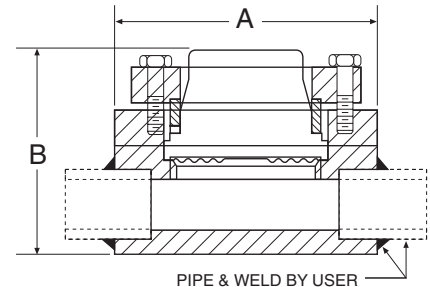

Pipe Size	A in	A mm	B in	B mm
¼"			2½	(60)
½", ¾"			2½	(60)
1"			2½	(60)
1½"	4	(102)	2¾	(67)
2"			2¾	(67)